

HD-Technik  
Sachverständige

PARIS  
1928

**Santic**

Agema Atla 3 - 80-0204 Nordalm  
TYP. 1 max 40 20 20 - 20 max 40 20 20

BEZUGSSTAB:	DATE:	ZEICHNUNG:	PROJEKT:
SCHALTPLAN 30/6kW WKA	91.10.21/A	THEO FUHLÄNDER	

SEITE:	1	ANZAHL SEITEN:	1
DATE:	91.09.26	PROJEKT:	FUR 0001-001

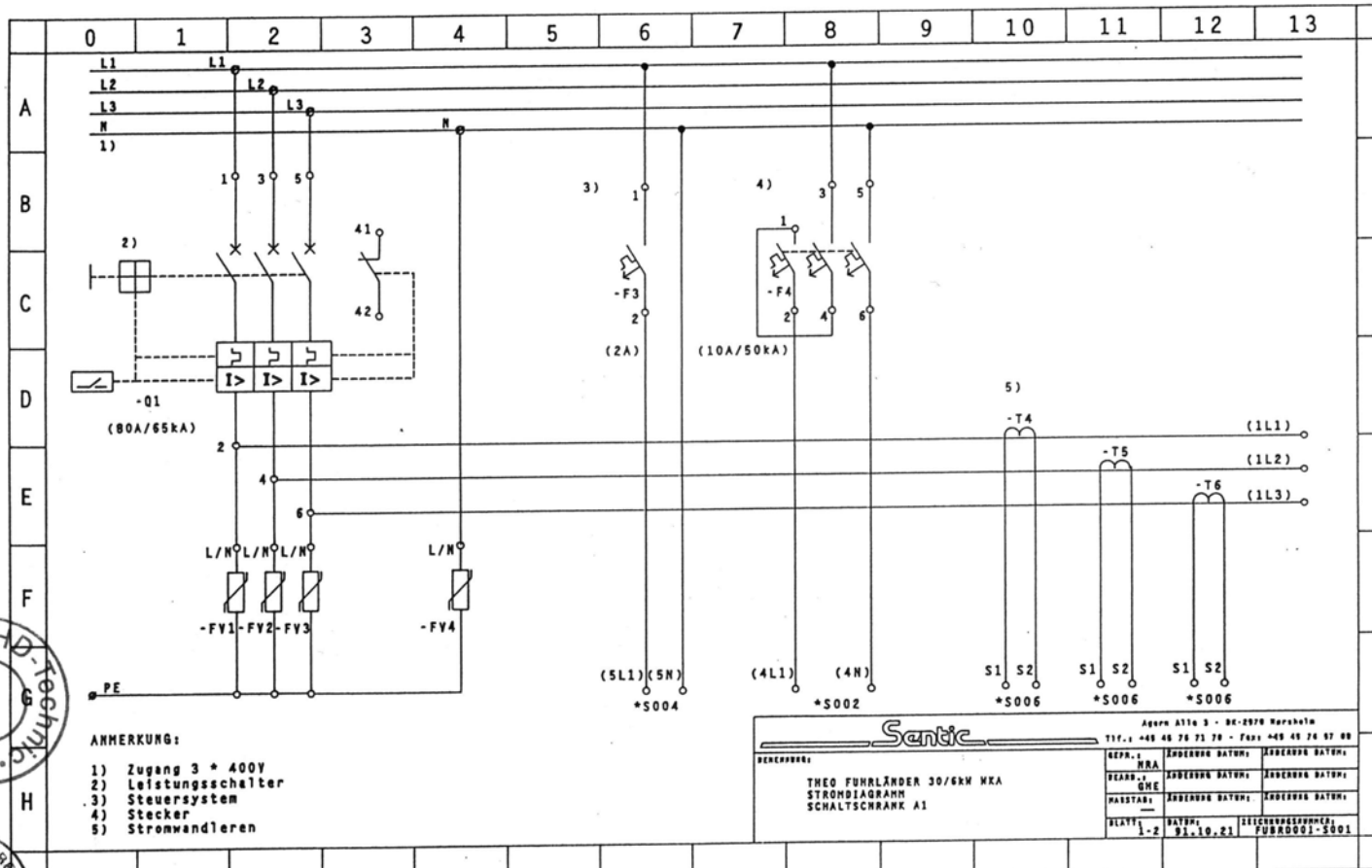



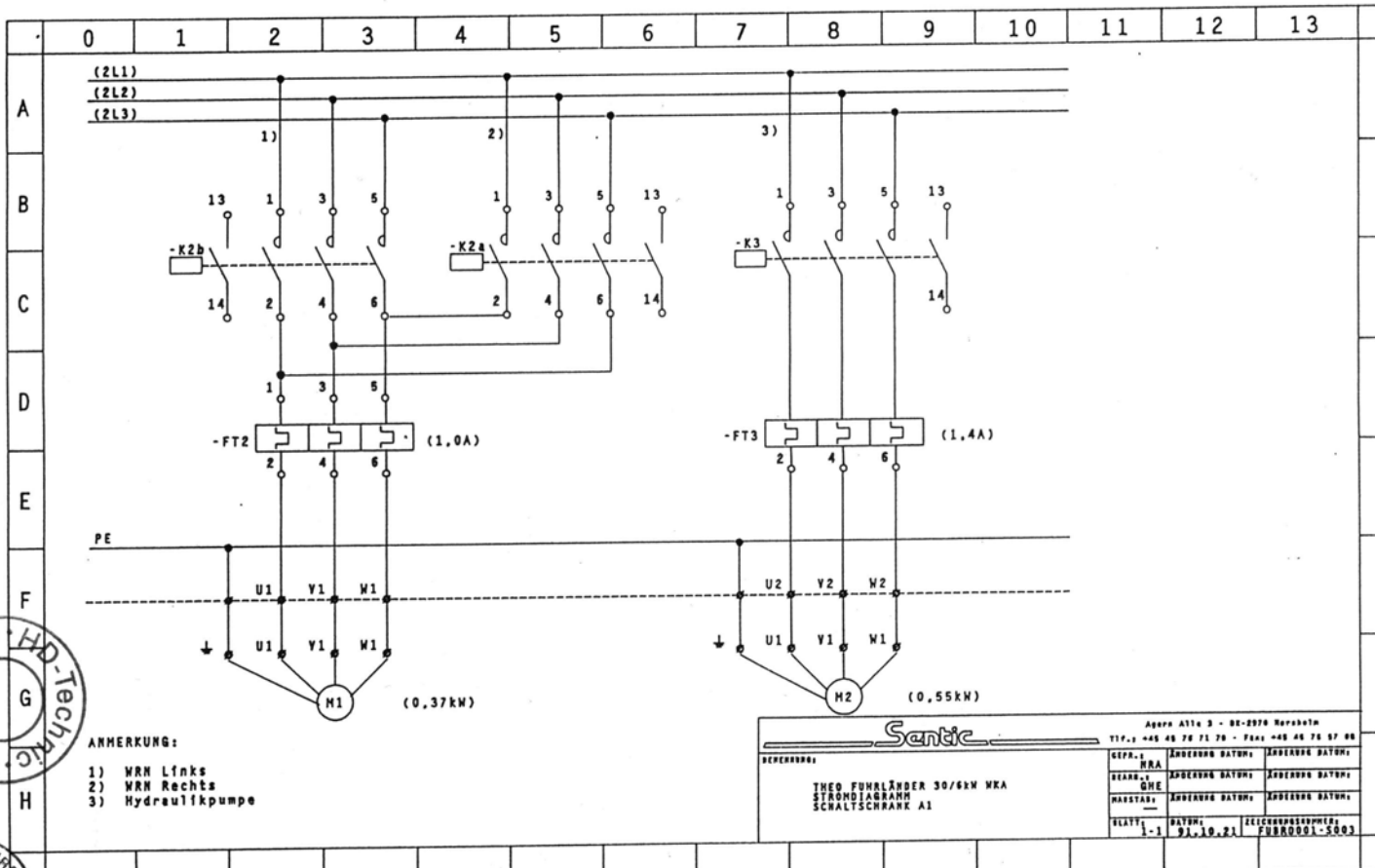

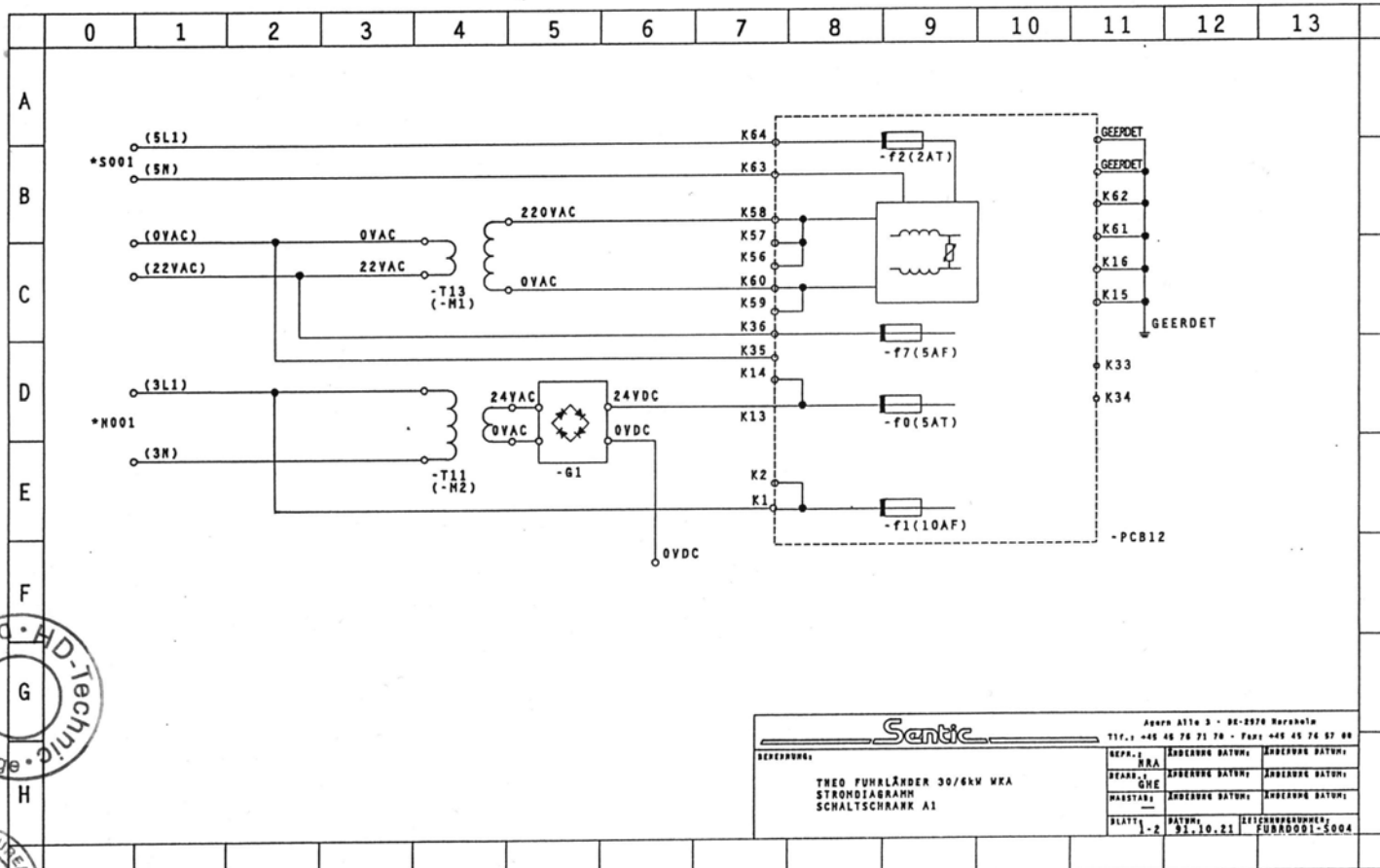

<b>Sentic</b>		Journ A11n 3 - 02-0076 Rev001a	
THERO FUHLÄNDER 30/6kW WKA STROMDIAGRAMM SCHALTSCHRANK A1		TIF. 1 - 46 46 74 71 70 - Fax: 46 46 74 67 00	
BEFEHL:	REP.:	ANBEREICH DATUM:	ANBEREICH DATUM:
	REAR:	ANBEREICH DATUM:	ANBEREICH DATUM:
	REWE:	ANBEREICH DATUM:	ANBEREICH DATUM:
	MASTAK:	ANBEREICH DATUM:	ANBEREICH DATUM:
	BLATT:	DATUM:	ZEICHENGRUPPEN:
	1-2	91.10.21	FUHLÄNDER-5004

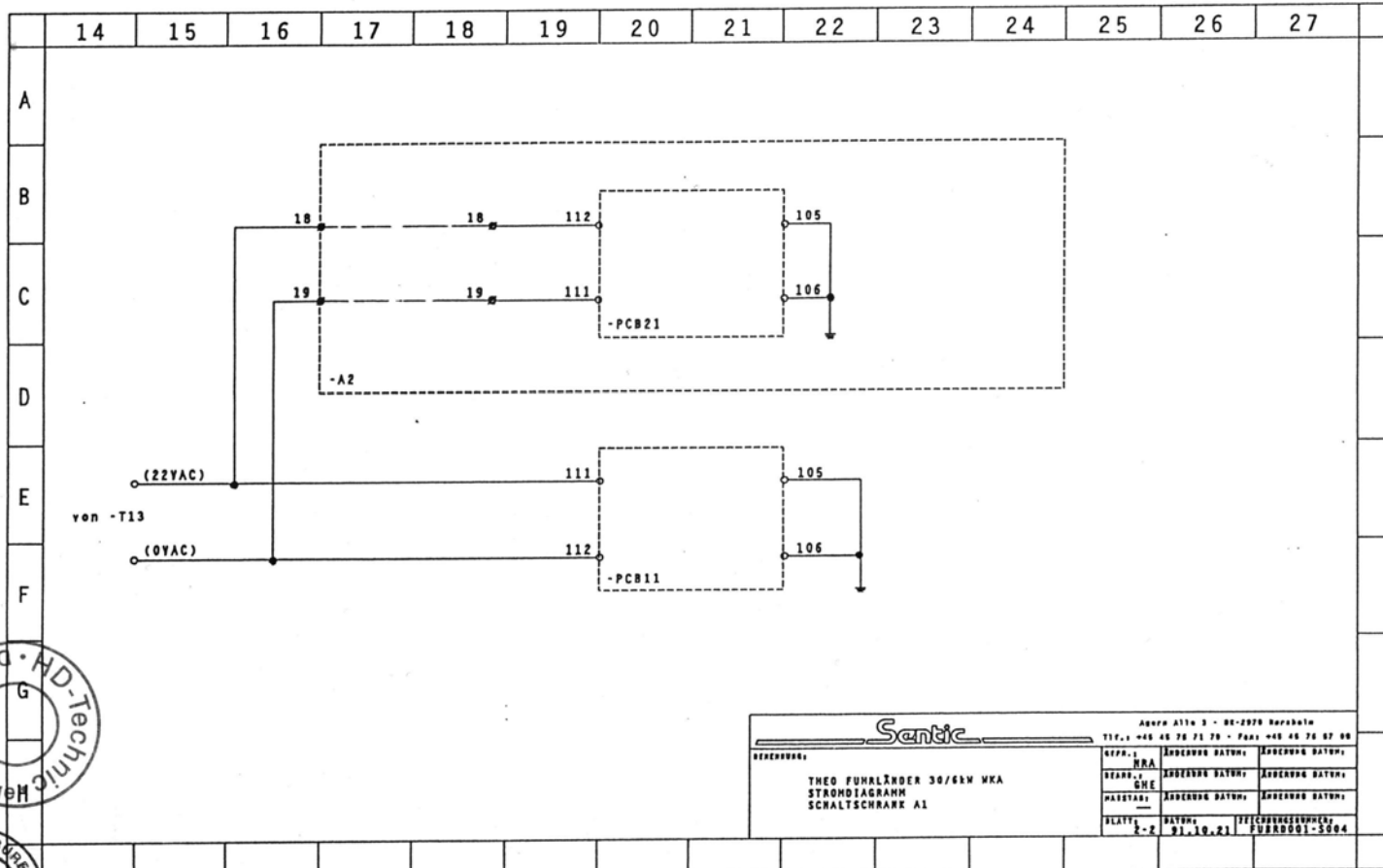

-7-



<b>Santic</b> Abform AT14 3 - DE-2978 Herabsetz T11: +48 46 76 71 70 - Paris +48 46 76 67 66		SEPP: 1	ÄNDERUNG DATUM:	ÄNDERUNG DATUM:
		BEARF.: HRA	ÄNDERUNG DATUM:	ÄNDERUNG DATUM:
THEO FUHLÄNDER 30/63M MKA STROMDIAGRAMM SCHALTSCHRANK A1		HAUSTAB: GHE	ÄNDERUNG DATUM:	ÄNDERUNG DATUM:
		PLATE: 2-2	DATUM: 01.10.21	STÜCKNUMMERSUPPL: FUHR001-3004

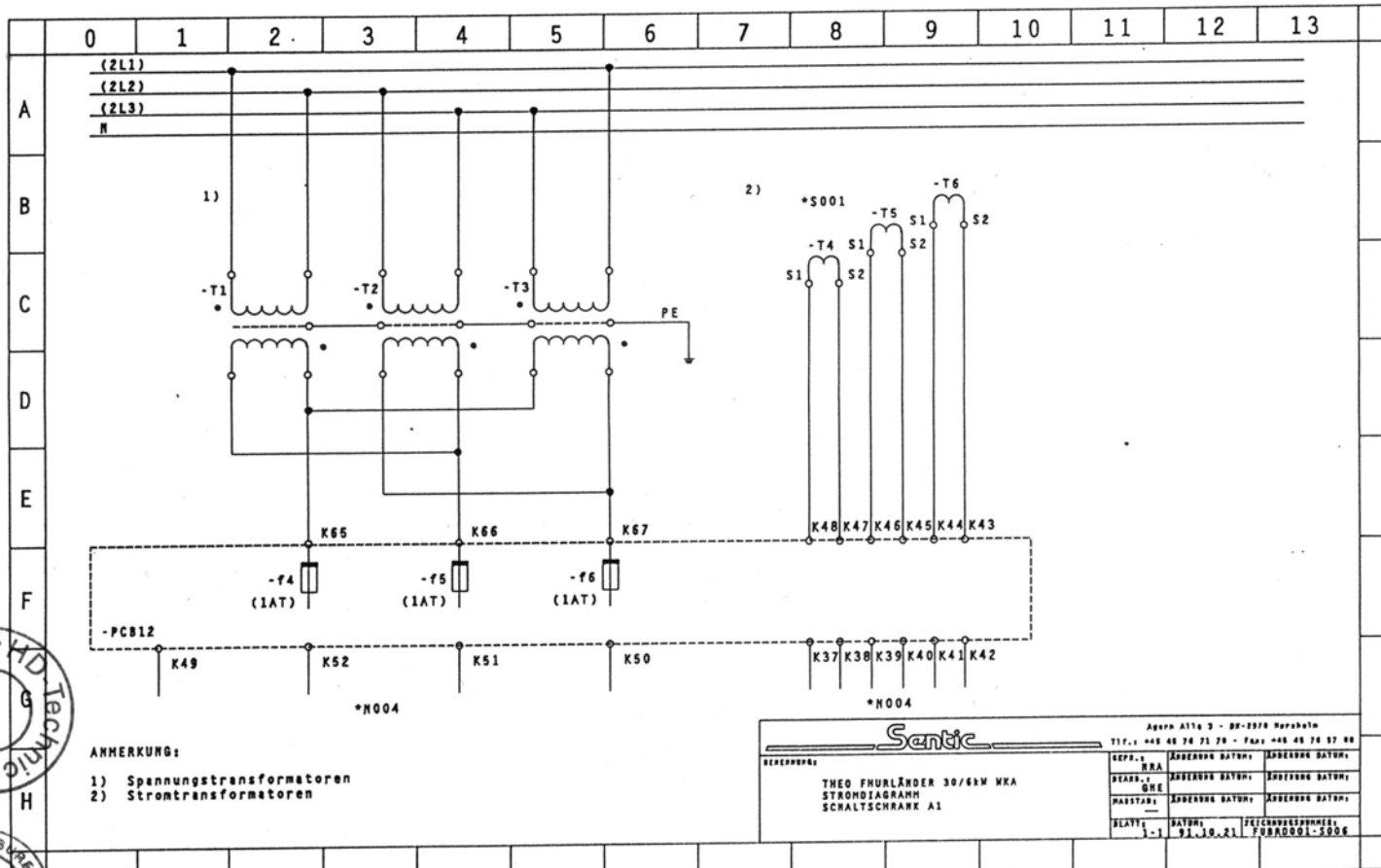

ANMERKUNG:  
 1) Spannungstransformatoren  
 2) Stromtransformatoren

**Santic**  
 THEO FHURLÄNDER 30/63M MKA  
 STROMDIAGRAMM  
 SCHALTSCHRANK A1

LEP. 1	ÄNDERUNG DATUM:	ÄNDERUNG DATUM:
BEARB. 1	ÄNDERUNG DATUM:	ÄNDERUNG DATUM:
DRG	ÄNDERUNG DATUM:	ÄNDERUNG DATUM:
HAUST. 1	ÄNDERUNG DATUM:	ÄNDERUNG DATUM:
RELAYS	DATUM:	FECHTSCHLÜSSEL:
3-1	91.10.21	F000001-5006

Aruph A116 3 - 80-8376 Hauptplan  
 TIT. 1 445 45 70 71 72 - Fax: 445 45 74 87 88

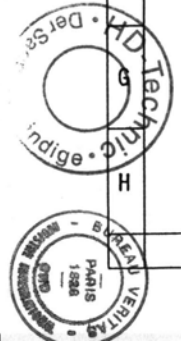



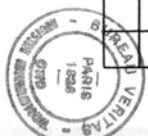
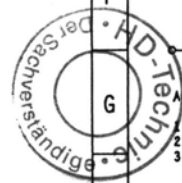
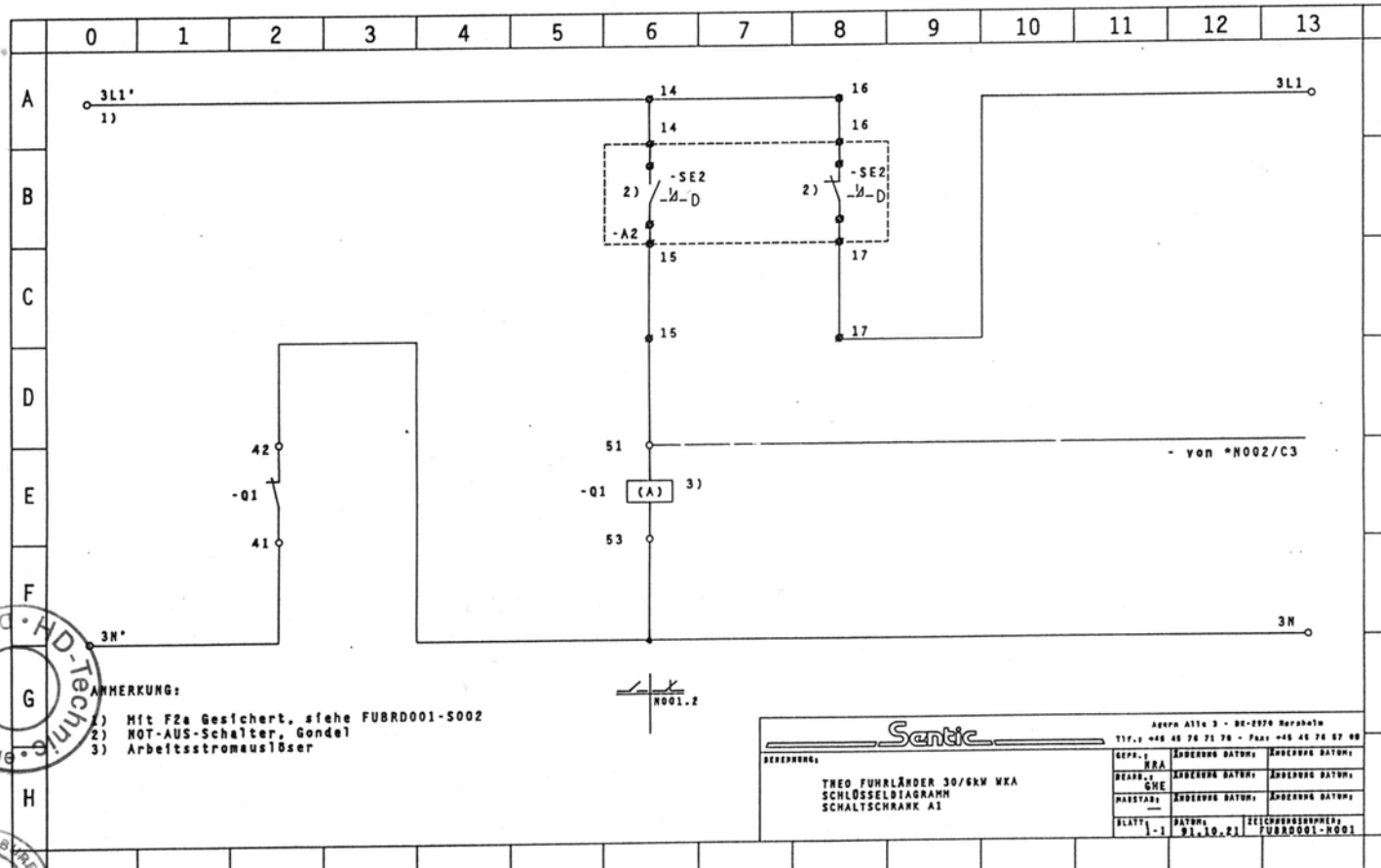

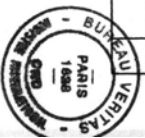
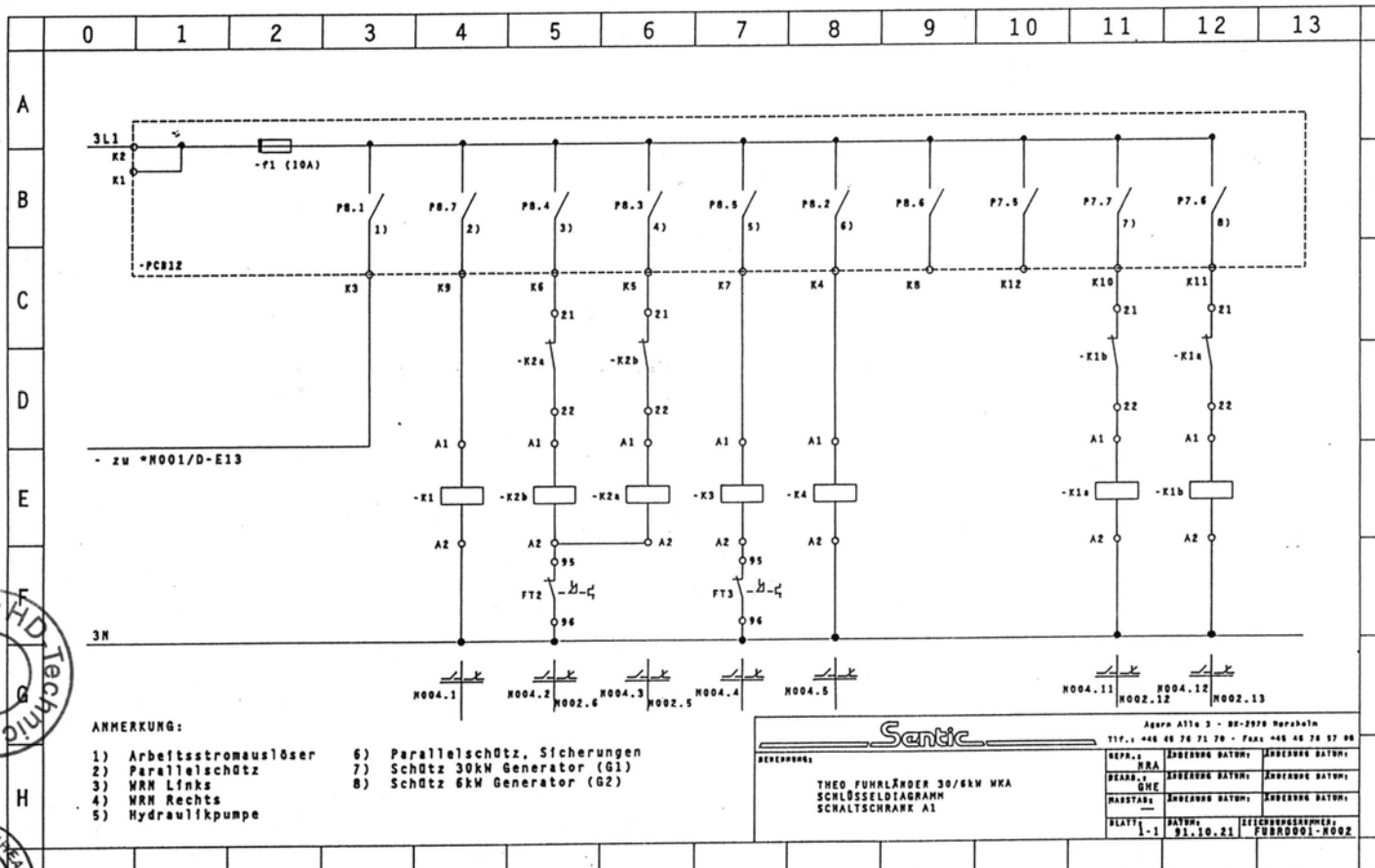

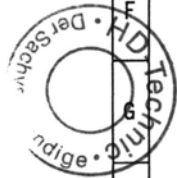
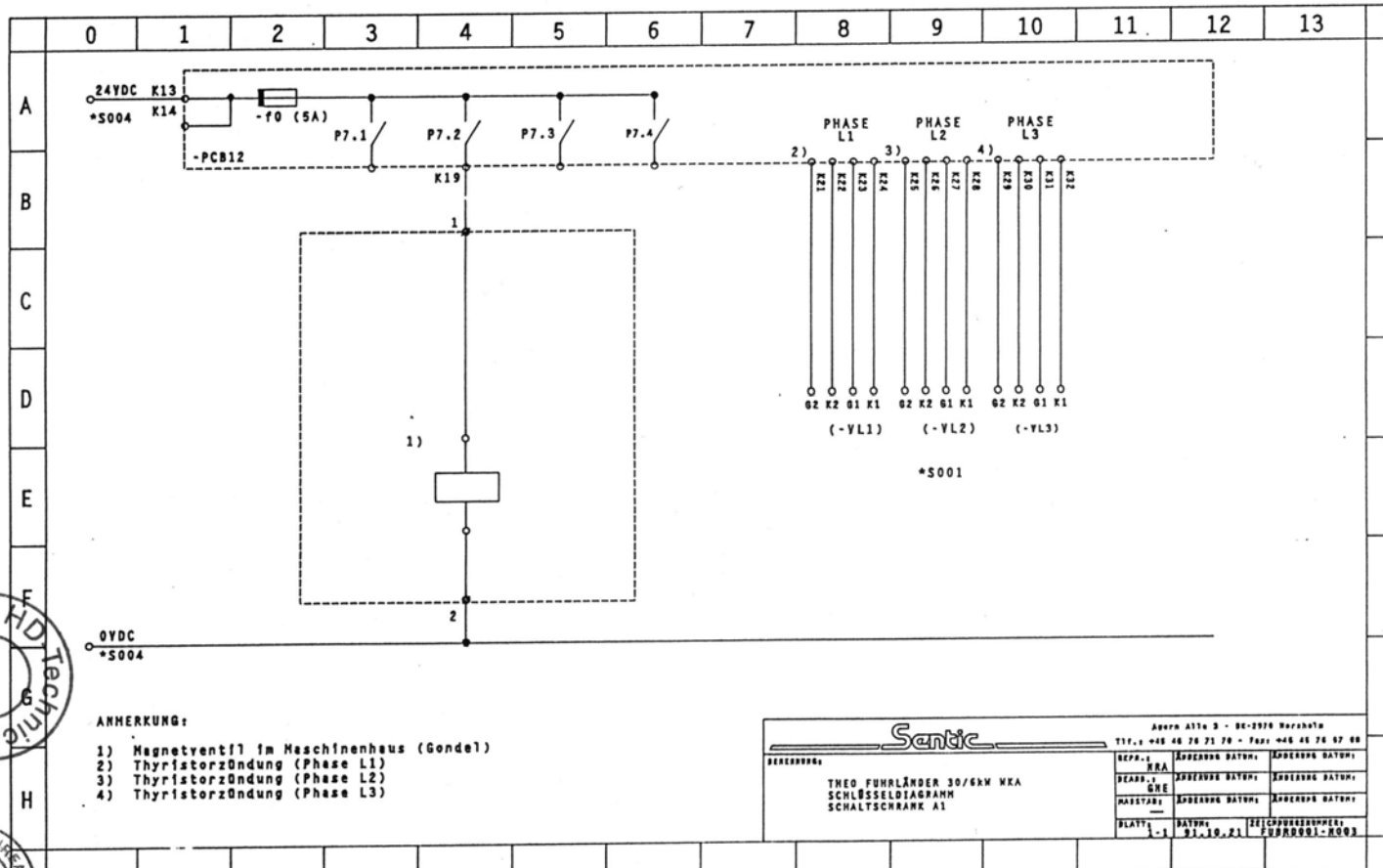

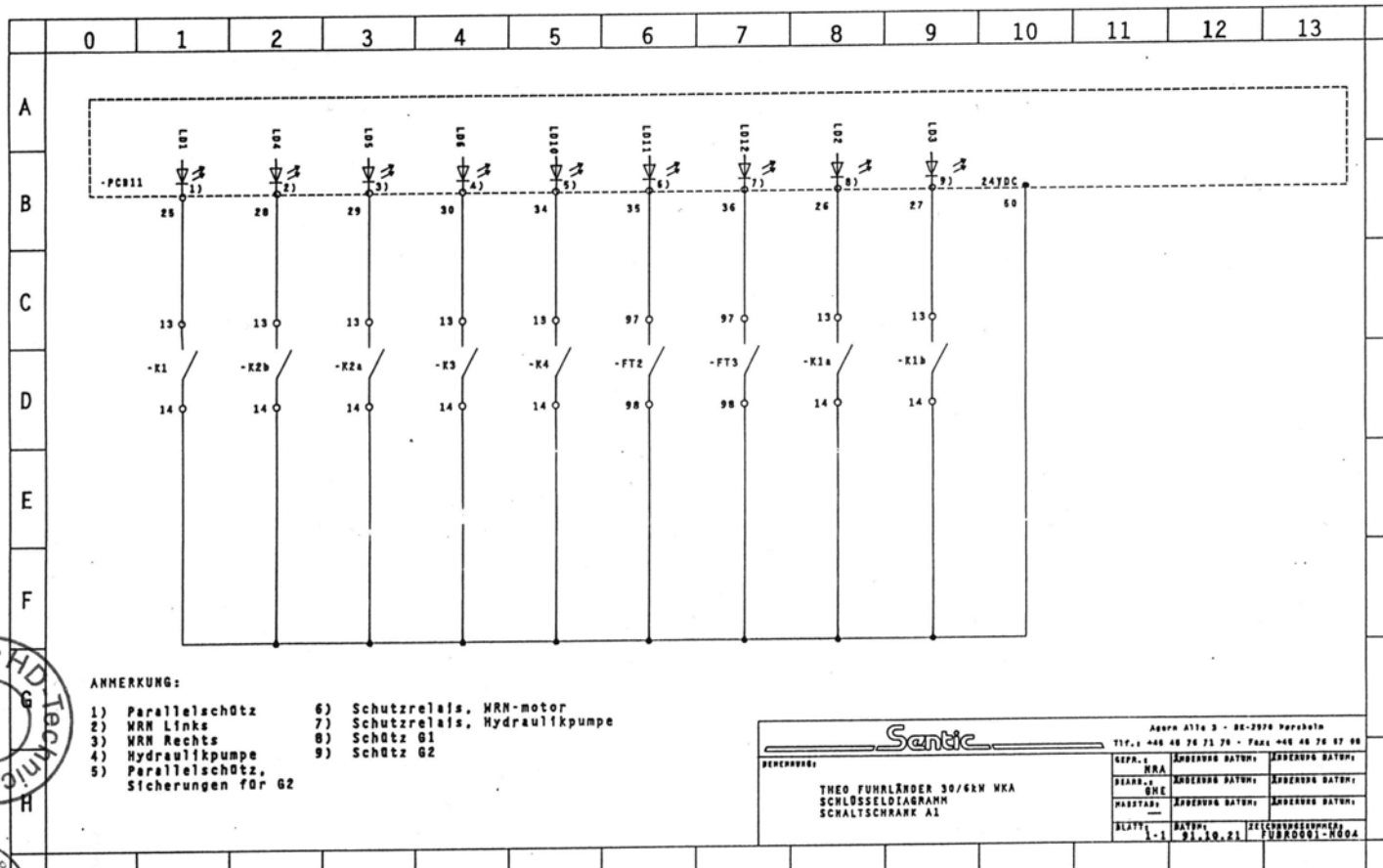

**Santic**

Agenc 3174 3 - 82-2078 Pappestein  
Tél.: +46 46 74 71 70 - Fax: +46 46 74 67 68

BEMERKUNG:	KEPR.: KRA	ÄNDERUNG DATUM:	ÄNDERUNG DATUM:
THEO FUHLRÖDER 30/62M WKA	ZEICHN.: GHE	ÄNDERUNG DATUM:	ÄNDERUNG DATUM:
SCHLÜSSELDIAGRAMM	PROJEKT:	ÄNDERUNG DATUM:	ÄNDERUNG DATUM:
SCHALTSCHRANK A1	BLATT: 1-1	DATUM: 21.10.21	ZEICHNUNGSPROJEKT: VBR0001-KUGA

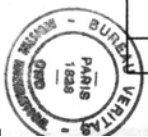
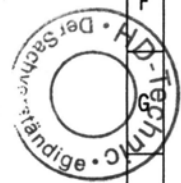
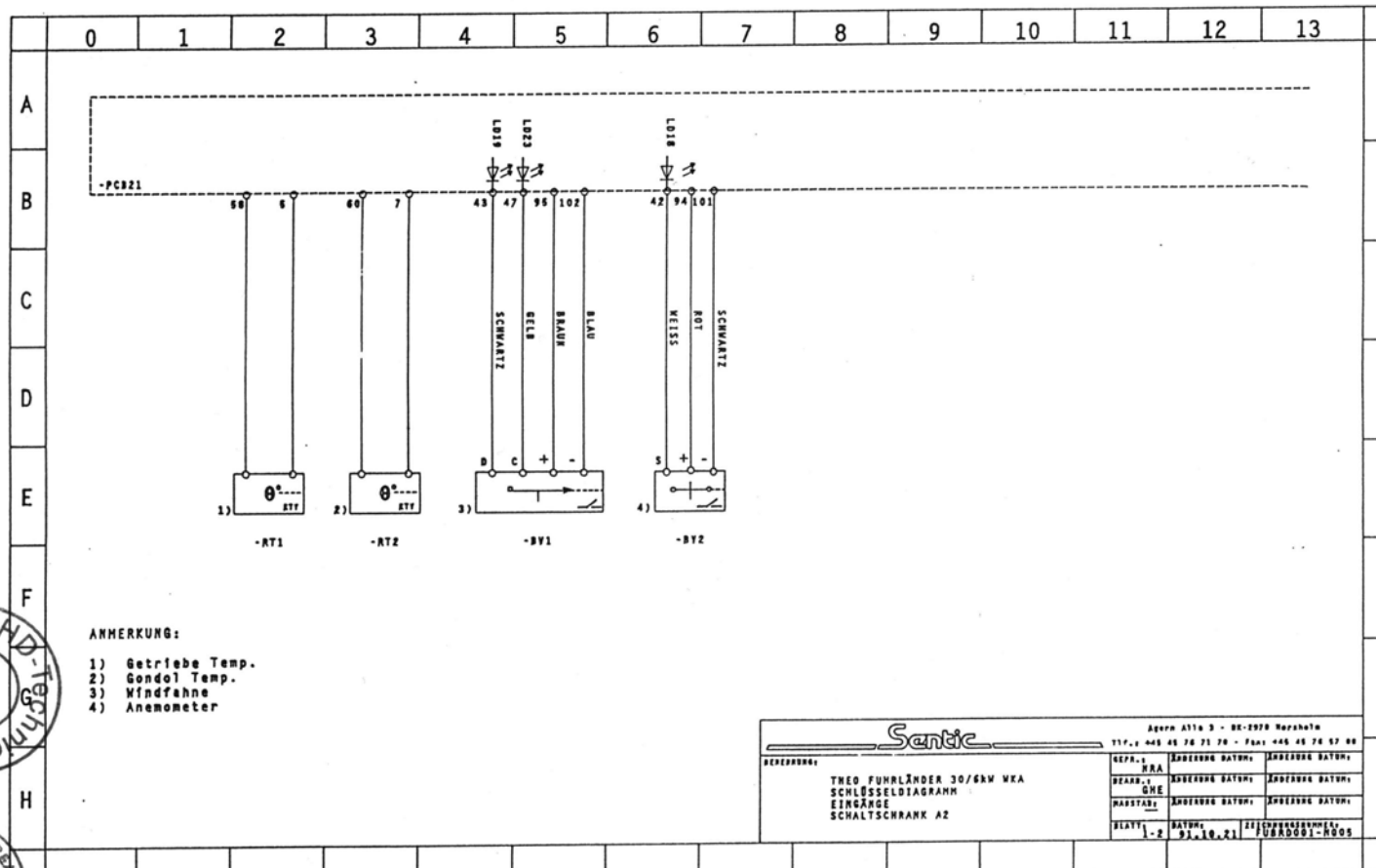

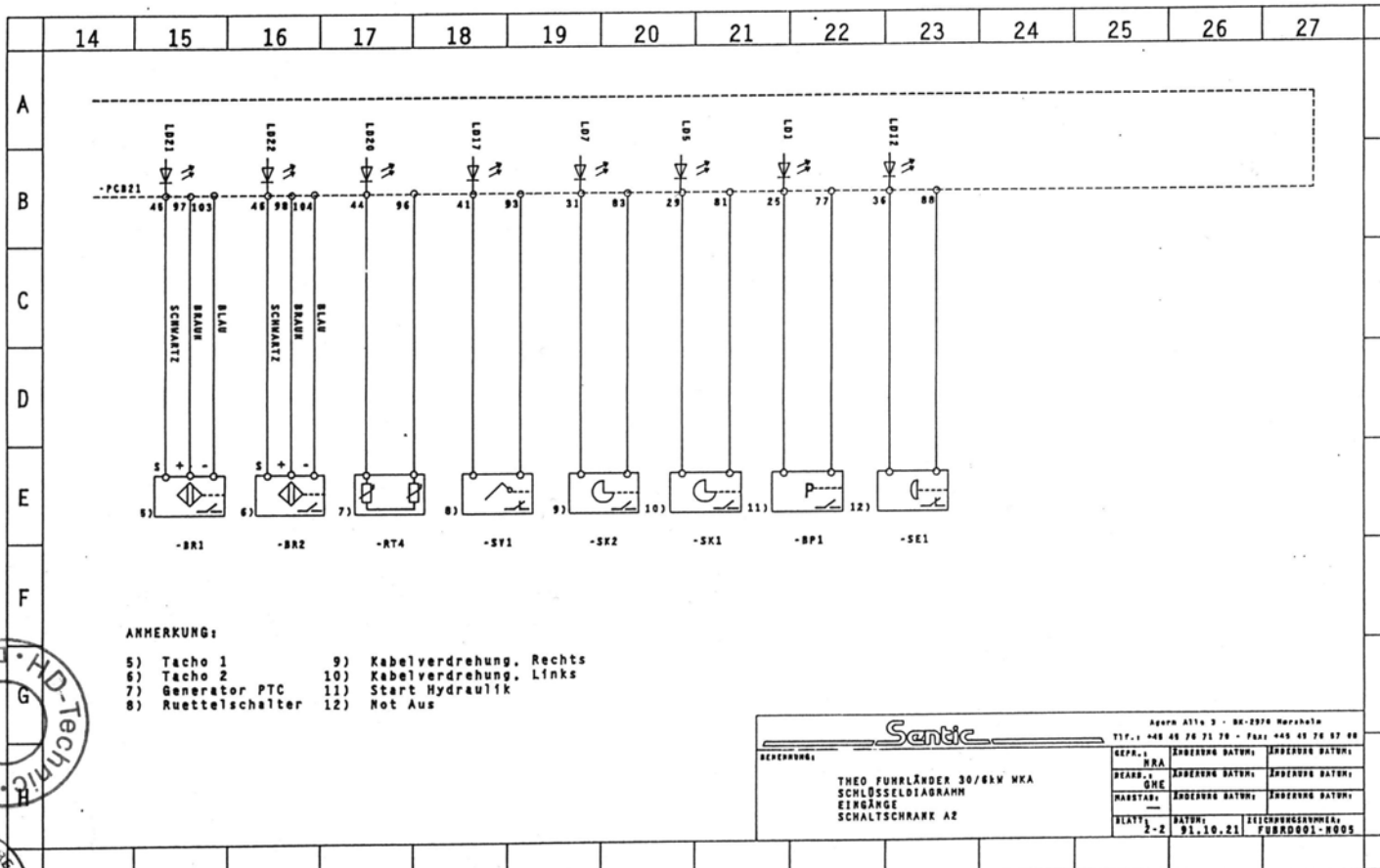

- ANMERKUNG:
- 5) Tacho 1
  - 6) Tacho 2
  - 7) Generator PTC
  - 8) Ruettelschalter
  - 9) Kabelverdrehung. Rechts
  - 10) Kabelverdrehung. Links
  - 11) Start Hydraulik
  - 12) Not Aus

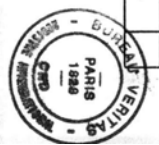
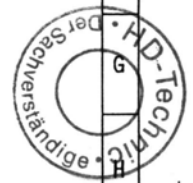

**Sentic**

Aachen Alt 3 - BK-2074 Hirschheim  
Tlf.: +49 49 76 21 76 - Fax: +49 49 76 97 98

BEZEICHNUNG:  THEO FUHLÄNDER 30/63M MKA SCHLÜSSELDIAGRAMM EINGÄNGE SCHALTSCHRANK A2	<table border="1" style="width: 100%; border-collapse: collapse;"> <tr> <td style="font-size: x-small;">GEPR. L.</td> <td style="font-size: x-small;">RRA</td> <td style="font-size: x-small;">ÄNDERUNG DATUM:</td> <td style="font-size: x-small;">ÄNDERUNG DATUM:</td> </tr> <tr> <td style="font-size: x-small;">GEPR. G</td> <td style="font-size: x-small;">GHE</td> <td style="font-size: x-small;">ÄNDERUNG DATUM:</td> <td style="font-size: x-small;">ÄNDERUNG DATUM:</td> </tr> <tr> <td style="font-size: x-small;">HABSTAB:</td> <td style="font-size: x-small;">—</td> <td style="font-size: x-small;">ÄNDERUNG DATUM:</td> <td style="font-size: x-small;">ÄNDERUNG DATUM:</td> </tr> <tr> <td style="font-size: x-small;">BLATT:</td> <td style="font-size: x-small;">2-2</td> <td style="font-size: x-small;">DATUM:</td> <td style="font-size: x-small;">ZEICHNUNGSAUFLAGE:</td> </tr> <tr> <td></td> <td></td> <td style="font-size: x-small;">91.10.21</td> <td style="font-size: x-small;">FUHADO01-NOOS</td> </tr> </table>	GEPR. L.	RRA	ÄNDERUNG DATUM:	ÄNDERUNG DATUM:	GEPR. G	GHE	ÄNDERUNG DATUM:	ÄNDERUNG DATUM:	HABSTAB:	—	ÄNDERUNG DATUM:	ÄNDERUNG DATUM:	BLATT:	2-2	DATUM:	ZEICHNUNGSAUFLAGE:			91.10.21	FUHADO01-NOOS
GEPR. L.	RRA	ÄNDERUNG DATUM:	ÄNDERUNG DATUM:																		
GEPR. G	GHE	ÄNDERUNG DATUM:	ÄNDERUNG DATUM:																		
HABSTAB:	—	ÄNDERUNG DATUM:	ÄNDERUNG DATUM:																		
BLATT:	2-2	DATUM:	ZEICHNUNGSAUFLAGE:																		
		91.10.21	FUHADO01-NOOS																		

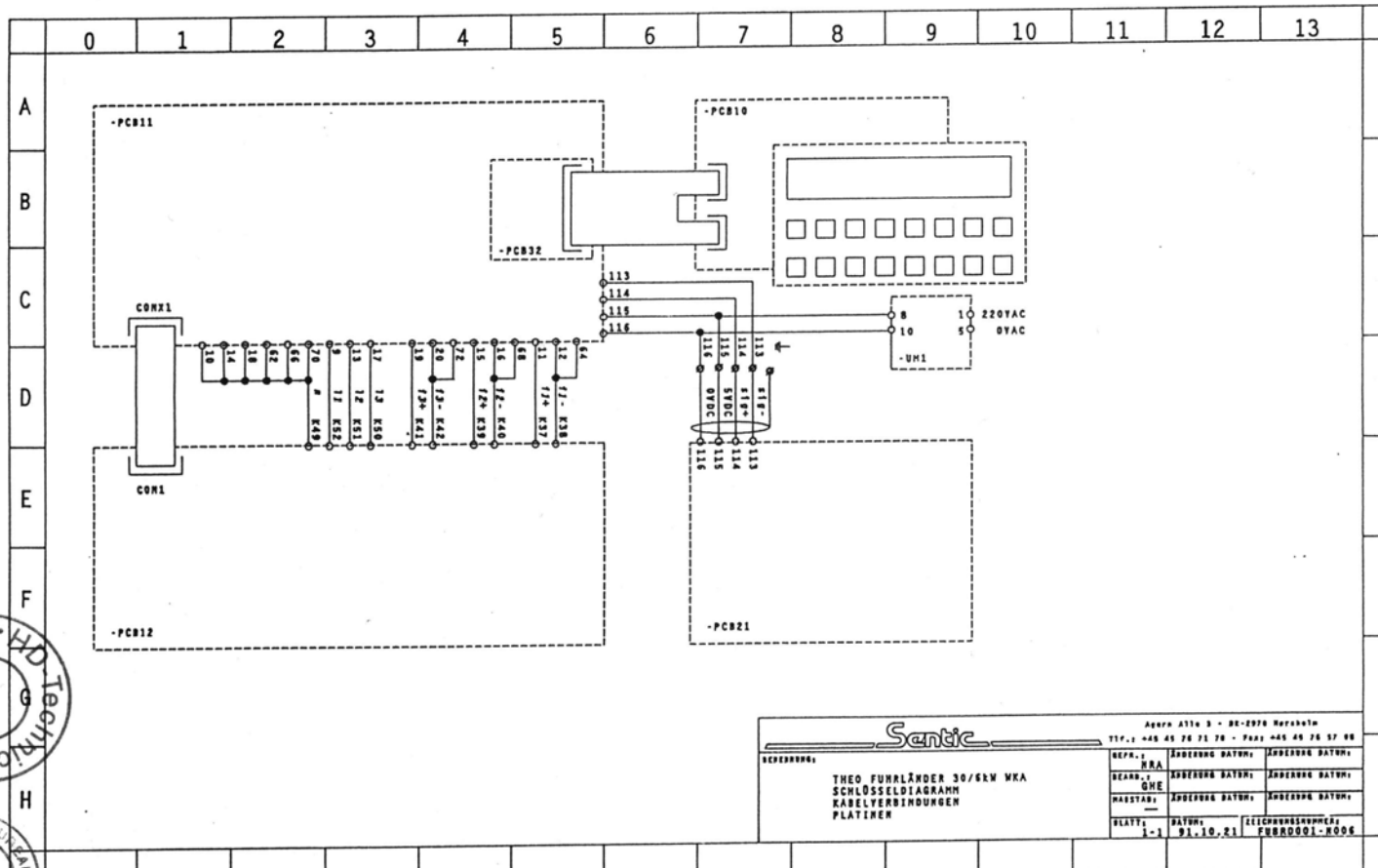







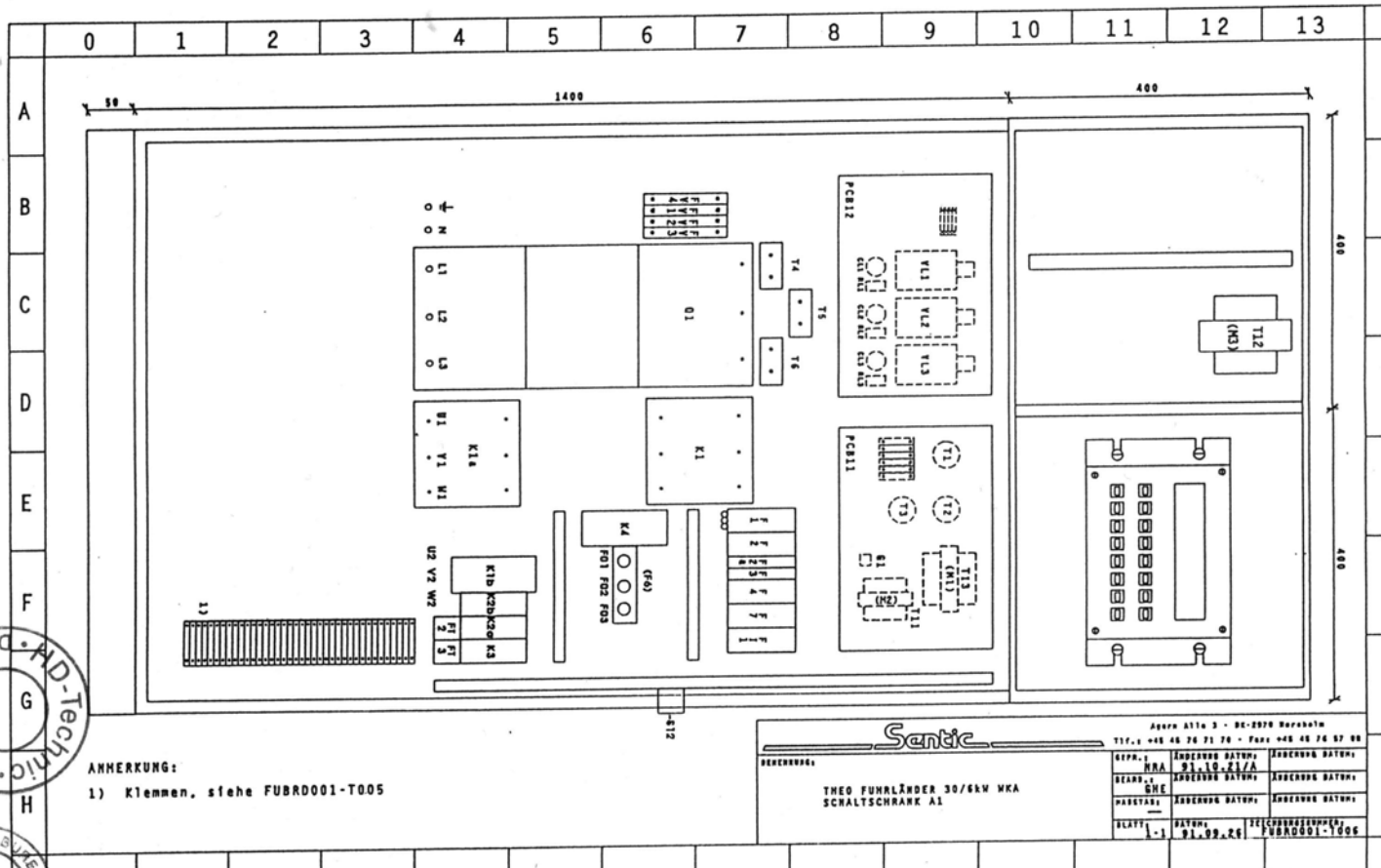

ANMERKUNG:  
1) Klemmen, siehe FUBR001-T005

**Senke**  
Agern Alte 3 - DE-2970 Horsteln  
Tlf.: +49 46 76 71 70 - Fax: +49 46 76 97 98

BEZUGS-NR.	ANFANG DATUM:	ENDE DATUM:
91.10.21/A	91.10.21/A	
ZEICHNUNG:	ANFANG DATUM:	ENDE DATUM:
91.10.21/A		
PROJEKTANT:	ANFANG DATUM:	ENDE DATUM:
SKALA:	1:1	ZEICHNUNGSPERSONEN:
		FUBR001-T005

THEO FUHLÄNDER 30/64W MKA  
SCHALTSCHRANK A1

